

NR miniature Series



CARATTERISTICHE GENERALI / GENERAL CHARACTERISTICS

Versione / Version	K	N	L	S	W	T
Corrente nominale a 250V A.C. / Rated current at 250V A.C.	10(2)A	6(2)A	6(2)A	6(2)A	16(3)A	10(2)A
Temperatura ambiente / Ambient temperature limits	-20° to 85°					
Grado di protezione / Degree of protection IP	00					
Classe di isolamento / Degree of protection against electric shock	I					
Grado di inquinamento / Pollution degree	2					
Tensione tra i contatti / Breakdown voltage across contacts	1500V at 50Hz					
Cicli di vita meccanica / Nu. of mechanical cycles	30 M at 1Hz					
Cicli di vita elettrica / Nu. of electrical cycles	50000 (5E4)					
Indice di resistenza alle correnti superficiali / PTI Proof tracking index	250 V					
Tensione di tenuta ad impulso / Rated impulse withstand voltage	2,5 kV					
Tipo di cablaggio / Type of conductor to be connected to the terminals	Flexible conductor 1.5mm ²					
Approvazioni / Approvals	IMQ ; UL					
Norma / Standard	EN61058-A1:2002+A2:2008					

CODIFICA / CODE EXPLANATION

NR	-	1	K	5
----	---	---	---	---

Serie / Series

Contatti / Circuit

A = N.O.
C = N.C.
- = DEV.

Sovrastrutture di azionamento / Actuators

1 – 10 = Pulsante & Pulsante rotella / *Plungers & roller-plungers*
20 – 99 = Leve / *Levers*
100 – 999 = Versioni Speciali / *Special Versions*

Versione / Version

L = Forza azionante bassa / *Low operating force*
K = Forza azionante standard / *Standard operating force*
N = Forza azionante media / *Medium operating force*
W = Corrente nominale 16A / *Rated current 16A*
S = Contatti striscianti / *Creeping Contact*
T = Distanza dei contatti > 3mm / *Contact distance > 3mm*

Terminali / Terminals

1 = Vite serrafile / *Screw connection terminal*
2 = Attacco faston da 4.8X0.8mm / *Quick connect 4.8x0.80mm*
3 = Terminale a saldare corto / *Short solder terminal*
4 = Terminale a saldare lungo / *Long solder terminal*
5 = Attacco faston da 6.35X0.8mm / *Quick connect 6.35x0.80mm*

1 = Vite serrafile / *Screw connection terminal*

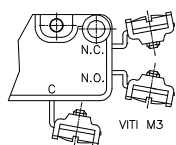

2 = Attacco faston da 4.8X0.8mm / *Quick connect 4.80x0.80mm*

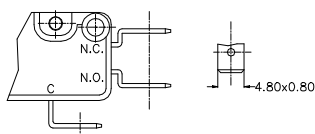

3 = Terminale a saldare corto / *Short solder terminal*

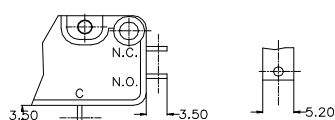

4 = Terminale a saldare lungo / *Long solder terminal*

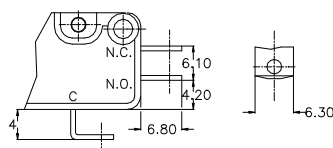

5 = Attacco faston da 6.35X0.8mm / *Quick connect 6.35x0.80mm*

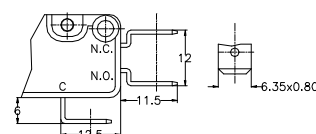

SOVRASTRUTTURA A PULSANTE / PLUNGER OPERATED SWITCHES

NR 1 K5

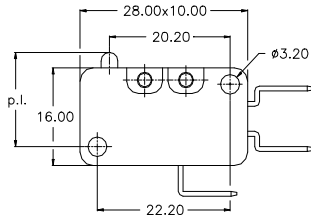

NR 3 K5 (plastica / plastic)

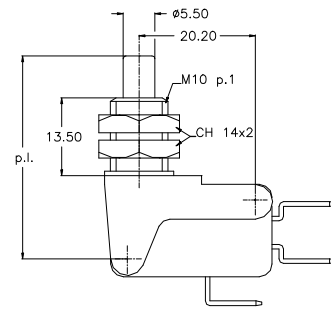

Modello Model	F.A./O.F. max gr	F.R./R.F. min gr	P.C./P.T. max mm	C.D./D.T. max mm	O.C./O.T. min mm	P.I./I.P. mm	P.S./S.P. med mm
NR 1 K	300	130	1.2	0.4	1.2	15.6	14.7
NR 3 K	330	130	1.5	0.4	4.0	35.5	34.0

NR6K5 (metallo / metal)

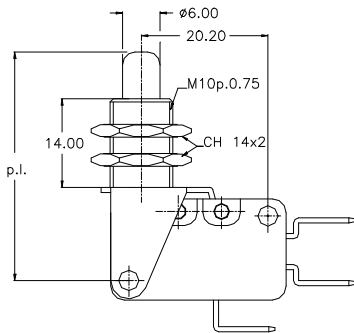

NR7K5

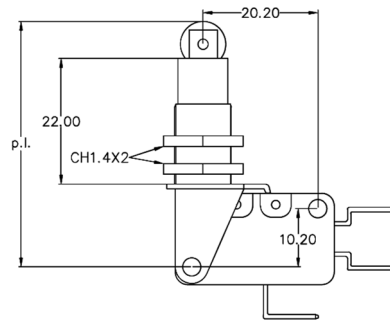

2NR4AK5 (double pole)

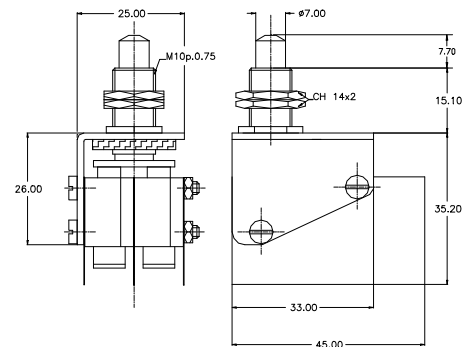

Modello Model	F.A./O.F. max gr	F.R./R.F. min gr	P.C./P.T. max mm	C.D./D.T. max mm	O.C./O.T. min mm	P.I./I.P. mm	P.S./S.P. med mm
NR 6 K	330	130	1.5	0.4	4.0	36.8	34.0
NR 7 K	300	130	1.2	0.4	1.2	43	41.5
2NR 4A K5	600	260	0.7	0.4	1.8	46	44

F.A.: Forza Azionante / O.F.: Operating Force
 F.R.: Forza di Ritorno / R.F.: Releasing Force
 P.C.: Precorsa / P.T.: Pre Travel
 C.D.: Corsa Differenziale / D.T.: Differential Travel

O.C.: Oltre Corsa / O.T.: Over Travel
 P.I.: Posizione Iniziale / S.P.: Initial Position
 P.S.: Posizione di Scatto / S.P.: Snapping Position

SOVRASTRUTTURA A LEVA SQUADRETTA / SIDE LEVER OPERATED SWITCHES

NR20K5

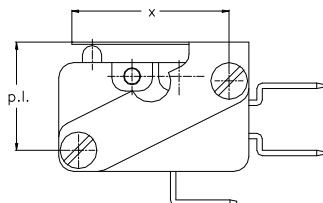

NR30K5

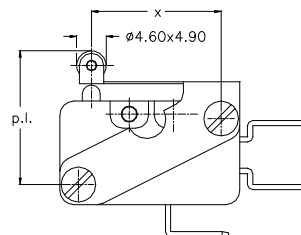

NR25K5

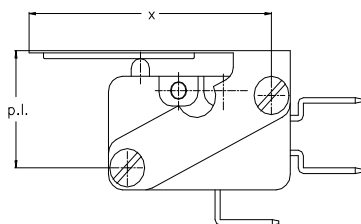

NR35K5

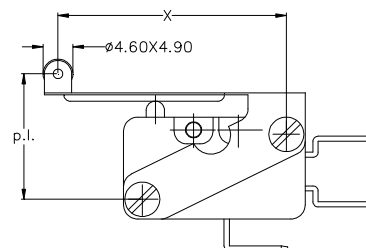

Modello Model	F.A./O.F. max gr	F.R./R.F. min gr	P.C./P.T. max mm	C.D./D.T. max mm	O.C./O.T. min mm	P.I./I.P. mm	P.S./S.P. med mm	L= X ±1 mm
NR 20 K	340	80	1.5	0.5	0.6	16.7	15	22.8
NR 25 K	220	80	2.5	1.0	1.0	17.8	16	37.3
NR 30 K	370	80	0.5	0.6	4.0	20.7	19	20.8
NR 35 K	130	50	3.0	1.5	2	23.7	21	36

F.A.: Forza Azionante / **O.F.:** Operating Force

F.R.: Forza di Ritorno / **R.F.:** Releasing Force

P.C.: Precorsa / **P.T.:** Pre Travel

C.D.: Corsa Differenziale / **D.T.:** Differential Travel

O.C.: Oltre Corsa / **O.T.:** Over Travel

P.I.: Posizione iniziale / **I.P.:** Initial Position

P.S.: Posizione di Scatto / **S.P.:** Snapping Position

L: Lunghezza Azionatore / **L:** Actuator Length

SOVRASTRUTTURA A LEVA / LEVER OPERATED SWITCHES

Azionamento invertito / *Reverse action*

Azionamento diretto / *Standard Operation*

NR41K ÷ NR50K5

NR52K ÷ NR60K5

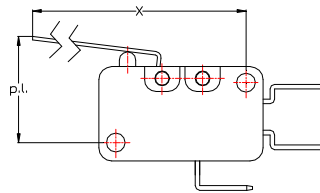
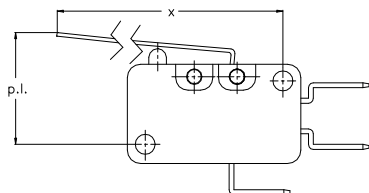

Modello <i>Model</i>	F.A./O.F. max <i>gr</i>	F.R./R.F. min <i>gr</i>	P.C./P.T. max <i>mm</i>	C.D./D.T. max <i>mm</i>	O.C./O.T. min <i>mm</i>	P.S./S.P. med <i>mm</i>	L = X±1 <i>mm</i>
NR 41 K	300	130	1.2	0.7	0.6	15.5	17.6
NR 42 K	250	100	2.0	0.7	0.8	15.5	26.5
NR 43 K	200	80	2.0	0.9	1.0	15.5	31.5
NR 44 K	170	60	2.5	1.1	1.2	15.5	36
NR 45 K	150	50	3	1.3	1.4	15.5	41.5
NR 46 K	130	45	3.5	1.5	1.6	15.5	45.5
NR 47 K	115	40	4.5	1.6	1.8	15.5	50
NR 48 K	100	35	5	1.8	2	15.5	54.5
NR 49 K	90	30	5.5	2	2.5	15.5	60
NR 50 K	75	25	6.5	2.5	3	15.5	70.5
NR 52 K	150	35	3.5	1.5	1.5	15	33
NR 53 K	130	30	4	2	2	15	38
NR 54 K	100	25	4.5	2	2.5	15	42.5
NR 55 K	75	20	5.5	2.5	3	15	48
NR 56 K	65	15	8	3	3.5	15	52
NR 57 K	55	12	8.5	3.5	4	15	56.5
NR 58 K	50	10	9	4	4.5	14.5	61
NR 59 K	45	8	9.5	4.5	5	14	66.5
NR 60 K	40	7	10.5	5	5.5	14	77

F.A.: Forza Azionante / O.F.: *Operating Force*

F.R.: Forza di Ritorno / R.F.: *Releasing Force*

P.C.: Precorsa / P.T.: *Pre Travel*

C.D.: Corsa Differenziale / D.T.: *Differential Travel*

O.C.: Oltre Corsa / O.T.: *Over Travel*

P.I.: Posizione iniziale / I.P.: *Initial Position*

P.S.: Posizione di Scatto / S.P.: *Snapping Position*

L: Lunghezza Azionatore / L: *Actuator Length*

SOVRASTRUTTURA A LEVA ROTELLA / ROLLER LEVER OPERATED SWITCHES

Azionamento Indiretto / *Standard operation*

NR31K5 ÷ NR34K5

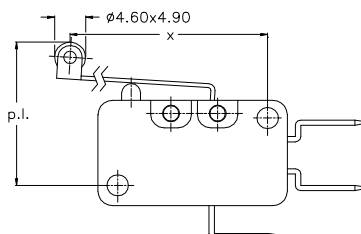

Azionamento diretto / *Reverse action*

NR51K5 & NR61K5 ÷ NR65K5

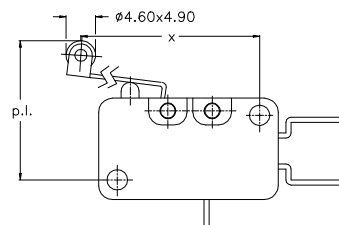

Modello <i>Model</i>	F.A./O.F. max <i>gr</i>	F.R./R.F. min <i>gr</i>	P.C./P.T. max <i>mm</i>	C.D./D.T. max <i>mm</i>	O.C./O.T. min <i>mm</i>	P.S./S.P. med <i>mm</i>	L = $x \pm 1$ <i>mm</i>
NR 31 K	300	130	1.2	0.7	0.6	21	21
NR 32 K	250	100	1.5	0.8	0.8	21	25
NR 33 K	200	80	2	1	1	21	30
NR 34 K	160	60	2.5	1.2	1.5	21	34.5
NR 51 K	200	40	3	1	1	15	39.1
NR 61 K	200	50	3	1.2	1	21	26.5
NR 62 K	150	40	3.5	1.5	1.5	21	31
NR 63 K	120	30	4.5	2.5	2	21	36
NR 64 K	100	20	5.5	3	2.5	21	40.5
NR 65 K	80	15	6	3.5	3	21	46

F.A.: Forza Azionante / **O.F.:** *Operating Force*

F.R.: Forza di Ritorno / **R.F.:** *Releasing Force*

P.C.: Precorsa / **P.T.:** *Pre Travel*

C.D.: Corsa Differenziale / **D.T.:** *Differential Travel*

O.C.: Oltre Corsa / **O.T.:** *Over Travel*

P.I.: Posizione iniziale / **I.P.:** *Initial Position*

P.S.: Posizione di Scatto / **S.P.:** *Snapping Position*

L: Lunghezza Azionatore / **L:** *Actuator Length*

SOVRASTRUTTURA A LEVA ROTELLA Ø 10mm / Ø 10mm ROLLER LEVER OPERATED SWITCHES

NR105

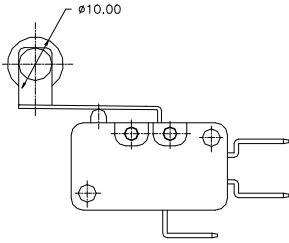

NR118 (double pole)

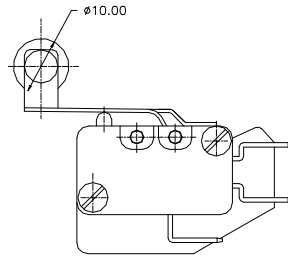

NR118 (double pole)

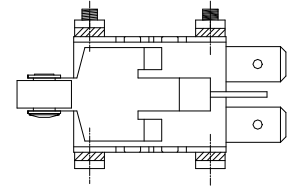

Modello	F.A./O.F. max	F.R./R.F. min	P.C./P.T. max	C.D./D.T. max	O.C./O.T. min	P.S./S.P. med	L = X±1
Model	gr	gr	mm	mm	mm	mm	mm
NR 105	250	100	1.5	0.8	0.8	21.6	21
NR 118	160	60	2.5	1.2	1.5	22.9	21

SOVRASTRUTTURA A LEVA FINTA ROTELLA / SIMULATED ROLLER LEVER OPERATED SWITCHES

Azionamento Indiretto / Standard operation

Azionamento diretto / Reverse action

NR82K5 ÷ NR85K5

NR92K5 ÷ NR95K5

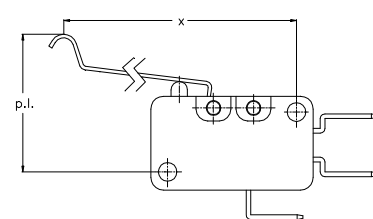
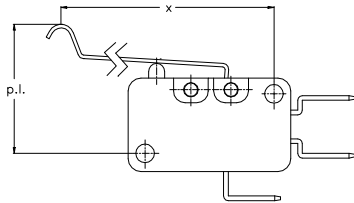

Modello	F.A./O.F. max	F.R./R.F. min	P.C./P.T. max	C.D./D.T. max	O.C./O.T. min	P.S./S.P. med	L = X±1
Model	gr	gr	mm	mm	mm	mm	mm
NR 82 K	250	100	1.5	0.8	0.8	21	25
NR 84 K	160	60	2.5	1.2	1.5	21	34.5
NR 92 K	150	40	3.5	1.5	1.5	20	31
NR 94 K	100	20	5.5	3	2.5	20	40.5

F.A.: Forza Azionante / **O.F.:** Operating Force

F.R.: Forza di Ritorno / **R.F.:** Releasing Force

P.C.: Precorsa / **P.T.:** Pre Travel

C.D.: Corsa Differenziale / **D.T.:** Differential Travel

O.C.: Oltre Corsa / **O.T.:** Over Travel

P.I.: Posizione iniziale / **I.P.:** Initial Position

P.S.: Posizione di Scatto / **S.P.:** Snapping Position

L: Lunghezza Azionatore / **L:** Actuator Length

PULSANTE INTERLOCK IN PLASTICA / INTERLOCK PLASTIC PLUNGER

NR72K5

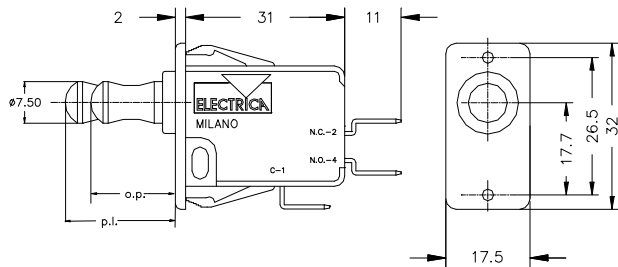

NR73K5 (double pole)

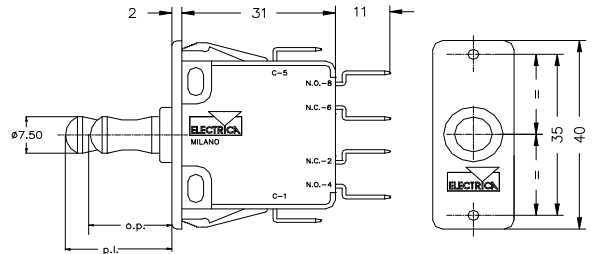

Modello <i>Model</i>	F.A./O.F. max <i>gr</i>	F.R./R.F. min <i>gr</i>	O.C./O.T. min <i>mm</i>	P.I./I.P. <i>mm</i>	P.S./S.P. med <i>mm</i>	P.M./M.P. <i>mm</i>
NR 72 K	500	100	10.5	16.2	14.2	21.5
NR 73 K	825	175	10.5	16.5	14.2	21.5

PULSANTE INTERLOCK IN ACCIAIO / INTERLOCK METAL PLUNGER

1NR31K5

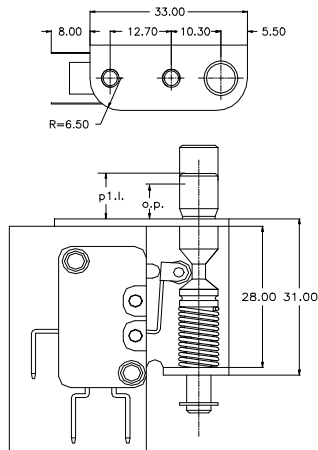

2NR31K5 (double pole)

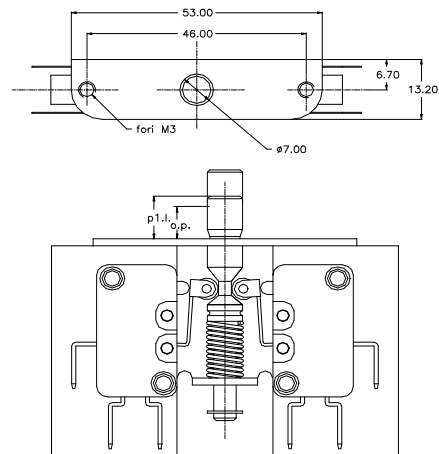

Modello <i>Model</i>	F.A./O.F. max <i>gr</i>	F.R./R.F. min <i>gr</i>	P.I./I.P. <i>mm</i>	P.S./S.P. med <i>mm</i>	P.M./M.P. <i>mm</i>
1 NR 31K	1300	-	9.5	4.1	15.5
2 NR 31K	1330	-	9.5	4.1	15.5

F.A.: Forza Azionante / **O.F.:** Operating Force
F.R.: Forza di Ritorno / **R.F.:** Releasing Force
P.I.: Posizione iniziale / **I.P.:** Initial Position

P.S.: Posizione di Scatto / **S.P.:** Snapping Position
P.M.: Posizione Manuale / **S.P.:** Manual Position

MICROINTERRUTTORE CON DISTANZA TRA I CONTATTI > 3mm

MICROSWITCH DISTANCE BETWEEN CONTACTS > 3mm

NR1T5

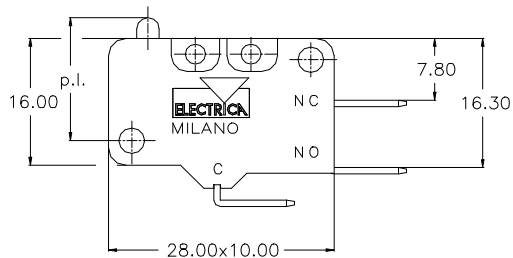

Modello <i>Model</i>	F.A./O.F. max <i>gr</i>	F.R./R.F. min <i>gr</i>	P.C./P.T. max <i>mm</i>	C.D./D.T. max <i>mm</i>	O.C./O.T. min <i>mm</i>	P.I./I.P. <i>mm</i>
NR 6 K	330	130	1.5	0.4	4.0	36.8

F.A.: Forza Azionante / **O.F.:** *Operating Force*

F.R.: Forza di Ritorno / **R.F.:** *Releasing Force*

P.C.: Precorsa / **P.T.:** *Pre Travel*

C.D.: Corsa Differenziale / **D.T.:** *Differential Travel*

O.C.: Oltre Corsa / **O.T.:** *Over Travel*

P.I.: Posizione Iniziale / **S.P.:** *Initial Position*

P.S.: Posizione di Scatto / **S.P.:** *Snapping Position*

ACCESSORI / ACCESSORIES

Connettori per cavetti compatibili con terminali faston da 6,35 x 0,80 mm (tipo 5)
Cable connector for faston terminals type 5

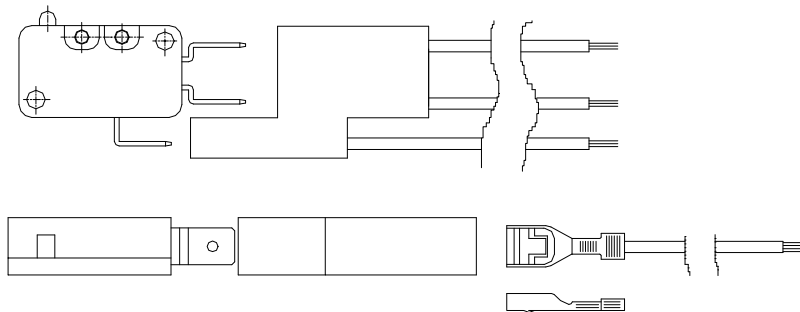

Protezione per microinterruttori con pulsante metallico interlock (model 1NR31)
Protection foldable casing for interlock metal plunger (model 1NR31)

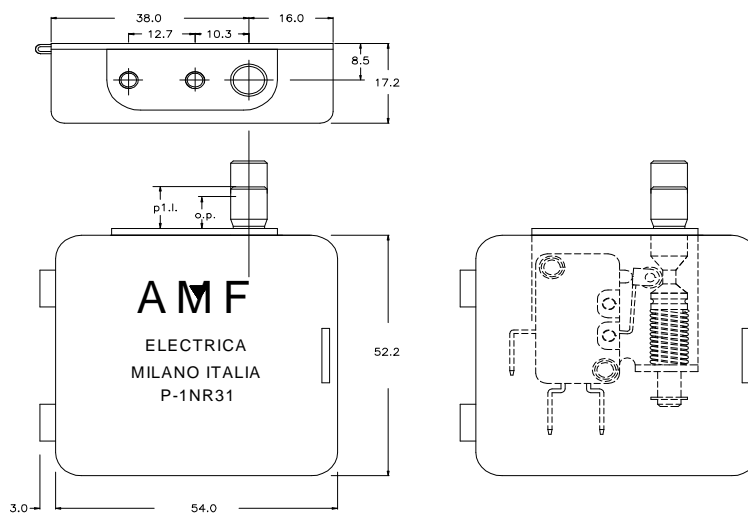



Electrica S.r.l.

Via privata Della Torre 24, 20127 Milano (MI) - Italia
Tel.: +39 02 2892641 - Fax: +39 02 2827511
Web: <http://www.electrica.it> - Email: info@electrica.it

Microswitches Division

Via D. Manin 350/21, 20099 Sesto San Giovanni (MI) - Italia
Tel.: +39 02 24300672 - Fax: +39 02 24303271
Email: microswitches@electrica.it
